



Anti-Sway™ Installation Manual

Greetings and Salutations!

We welcome you on your journey from a plain ol' dock user to an official dock aficionado! You are now a member of an elite club of dock specialists who appreciate the finer things in life. We encourage all of our members to learn about the many advantages of the Pier Genius dock system, in order to help others stay 'on the level' with their own docks. Let's sway opinions, not docks! ☺

The entire team at Pier Genius is comprised of good, hard-working folk, and we sincerely thank you for purchasing a quality-built Pier Genius Anti-Sway™ dock! If you have difficulty at any time during your installation, please contact us via e-mail at sales@piergenius.com or by phone at 641-357-1096. We answer questions promptly!

We would also love to hear your feedback once your installation is complete. Please send your thoughts on our product or the installation of our product to the e-mail listed above.

Remember, our docks are Pier Genius, but installing one is as easy as 1, 2, 3!

Ready to get started? Let's begin by getting the tools you'll need.

Tools Required:

9/16" socket

3/8" drill bit (If installing optional accessories)

4" socket extension (If installing bumpers)

Post Pounder (If anchoring vis pipe driven into the lakebed)

Definitions:

Dock sections = Our standard frames are 12" tall

and either 4'x8', 4'x10', 6'x8', or 6'x10'

Side of frame = Our standard frames are either 8' or 10' long

Width of frame = Our standard frames are 4' or 6' wide

End of frame = Same as the width but is the final end farthest out from shore

D2D Hinge = Connects **Dock To Dock** connections with a hinge

D2S Hinge = Anchors entire **Dock To Shore** with hinge attached to concrete abutment at shore to support frame gangway (which is different than a ramp)

PG Deck = Decking panels, typically 2 panels per section

2" Spud Pocket = fits a 1.5" sch 40 pipe

3" Spud Pocket = fits a 2" sch 40 pipe

Getting Started:

First, lay the Anti-Sway™ dock frames out in the sections you want to connect. One advantage of the Pier Genius system compared to an angle iron system is the ability to set the floats on the ground in order to set the frame right on top of them vs being required to flip the frame upside down to drill holes for the floats as is commonly done on an angle iron frame. Each frame weighs ~150lbs with decking, and the floats weigh another 48 lbs. each, so make sure you have enough people/equipment to lift multiple sections together and into the water. We personally build large sections on a trailer, then back the trailer into a launch ramp when complete and make any final connections on the water.

Important

The frames are designed so that only ONE side will support a 90 degree turn if you're going to make a finger on a "T", "L", or "U" shaped dock. As such, **MAKE SURE TO REFERENCE YOUR LAYOUT CAD TO ENSURE YOU HAVE THE FRAMES ORIENTED CORRECTLY BEFORE BOLTING THE FLOATS ON.**

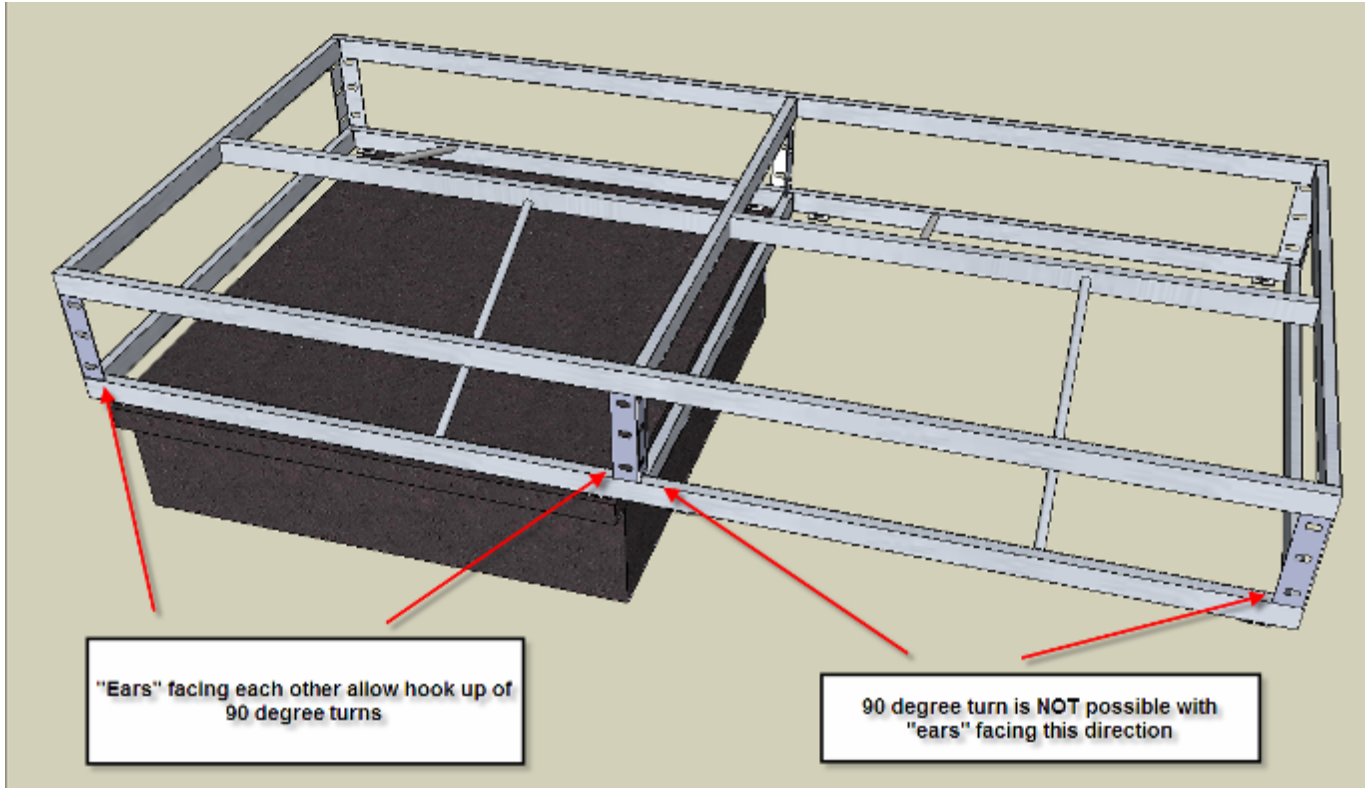

Rotate the frame 180 degrees to get the desired location for the 90 degree connection.

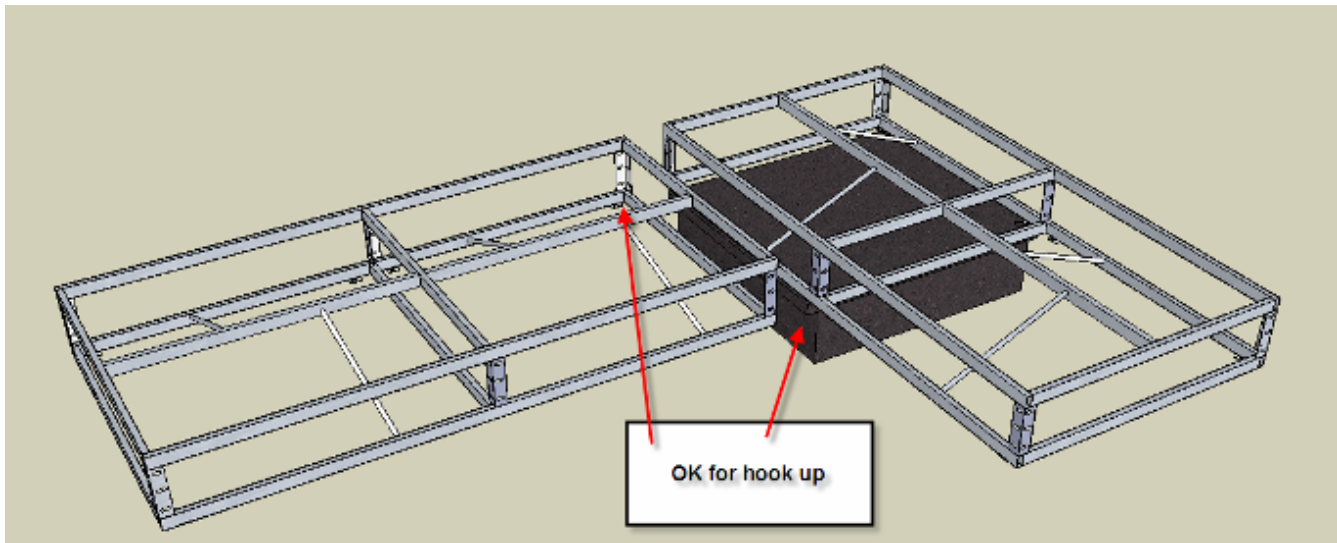

Connecting Floats to Frames:

Before attaching the floats to the Anti-Sway™ frame, make sure to screw in the plastic allen head plug into the float vent to ensure proper float ventilation.

Position the floats in accordance with the CAD drawing you received with your order. Our general rule of thumb is to position a float on all ends first and then spaced evenly throughout the system.

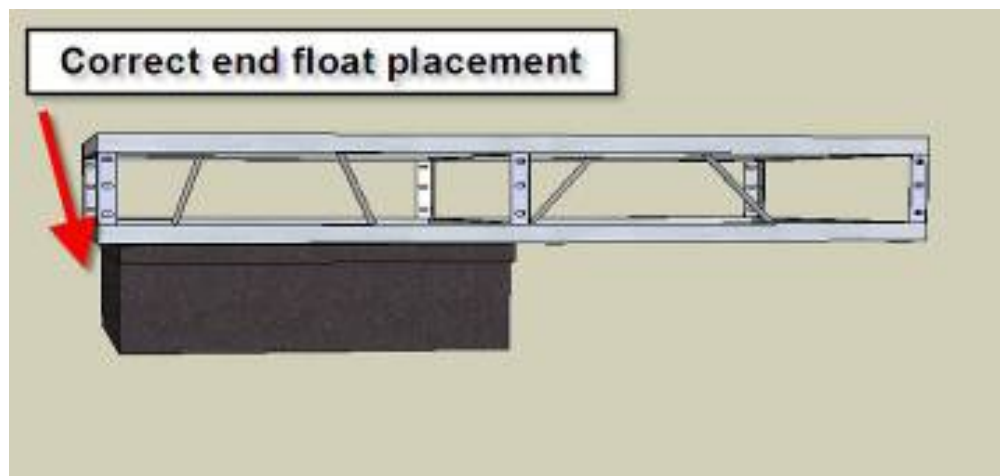
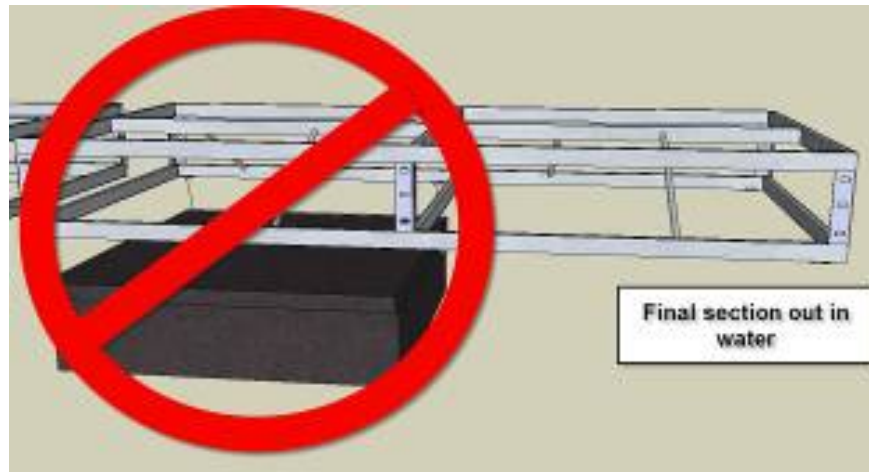

Connect the float to the frame at all 4 corners with the 2.5" galvanized hex bolts included with the shipment. There are actually 6 connections on float, but only 4 are necessary. Rotate the float until all four corners line up+++.



Sample hardware

Place the bolt through the slot in the frame. The head should fit tight against the side of the bottom tube to prevent the bolt from spinning when tightening.

Once the bolt is through the float slots, secure it with the large SS flat washer, smaller galvanized flat washer, lock washer, and then nut.

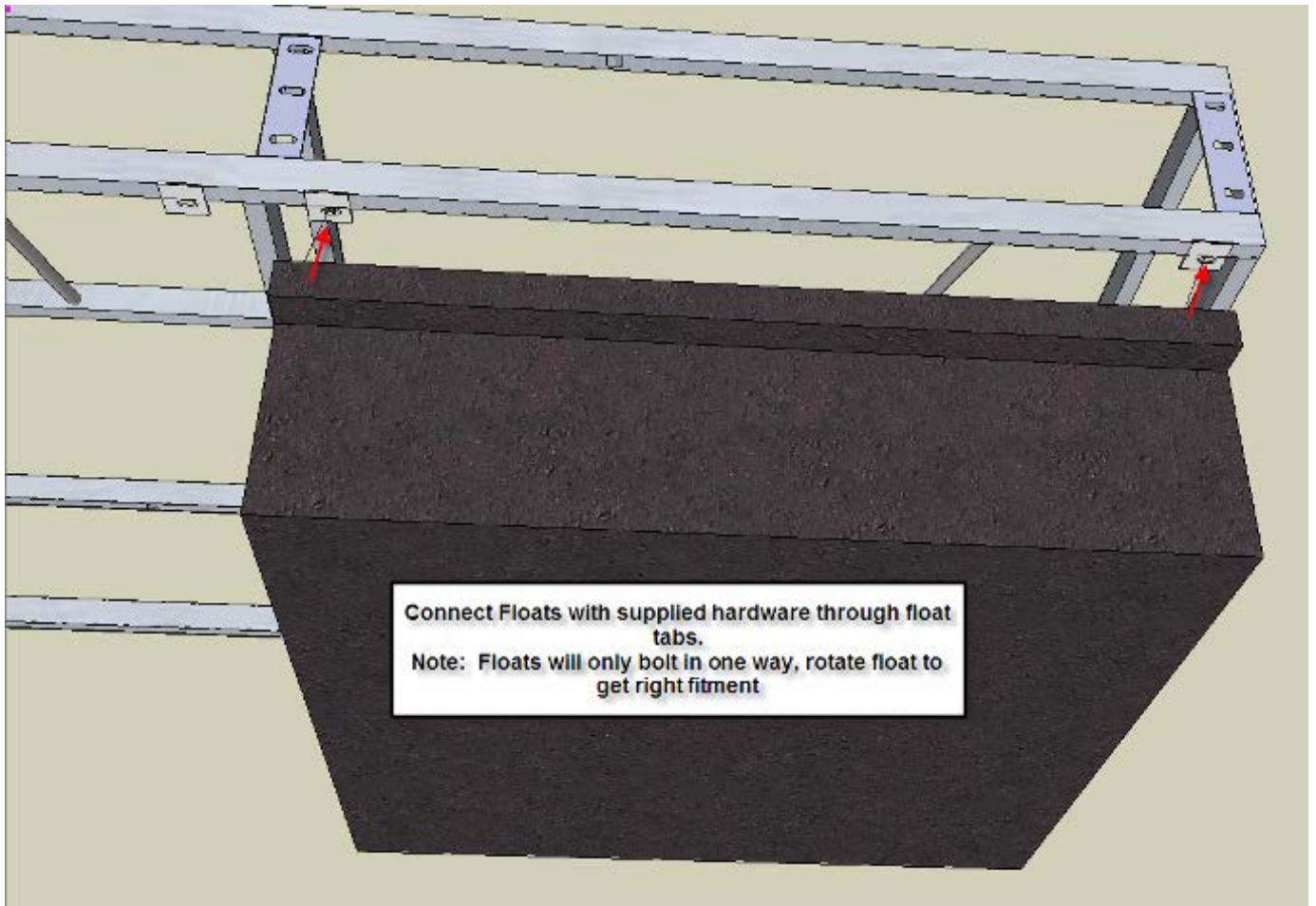

If your floats do not fit the tabs welded on the frame because they are not a 4x4 or 6x4 size, use the supplied float bracket to fasten the floats to the frames in the same manner as the tab installation listed above.

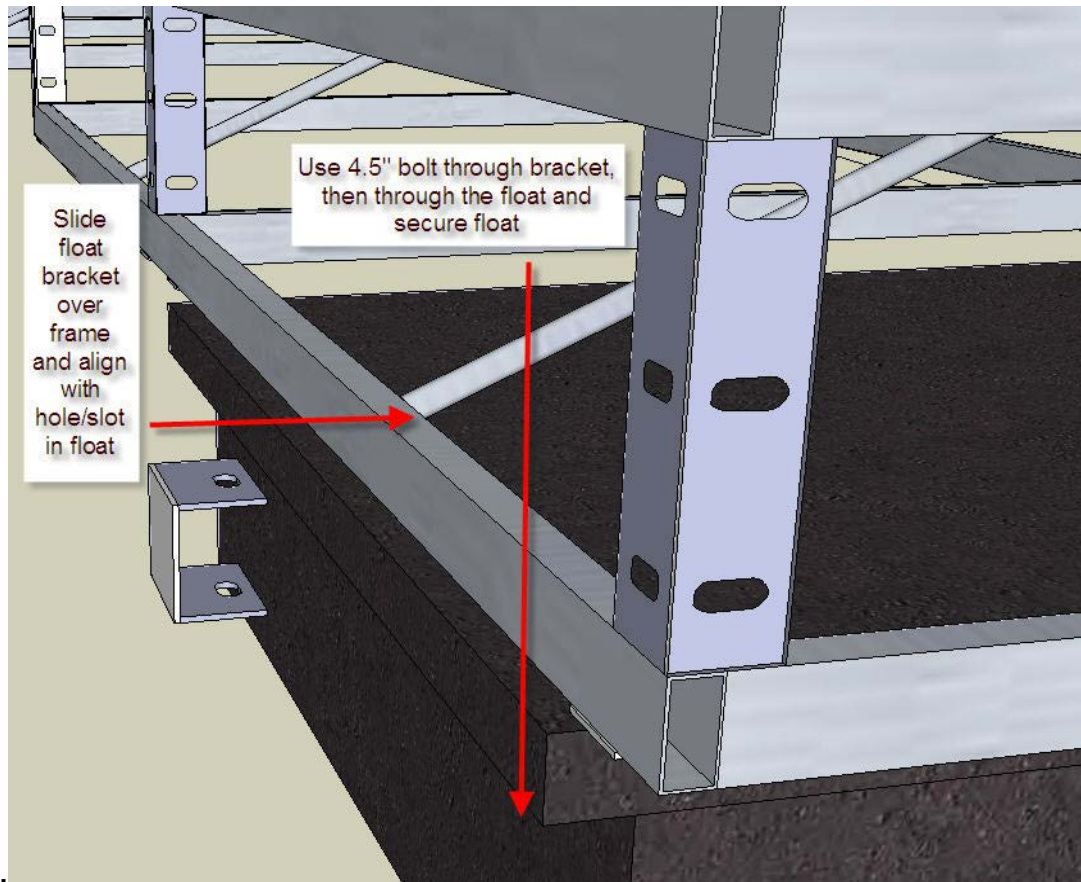

Connecting Frames Together:

Sections can be bolted together using the included 1" galvanized bolts included in the hardware kit. Use 6 bolts on end-to-end connections and 9 bolts on side-to-side connections.

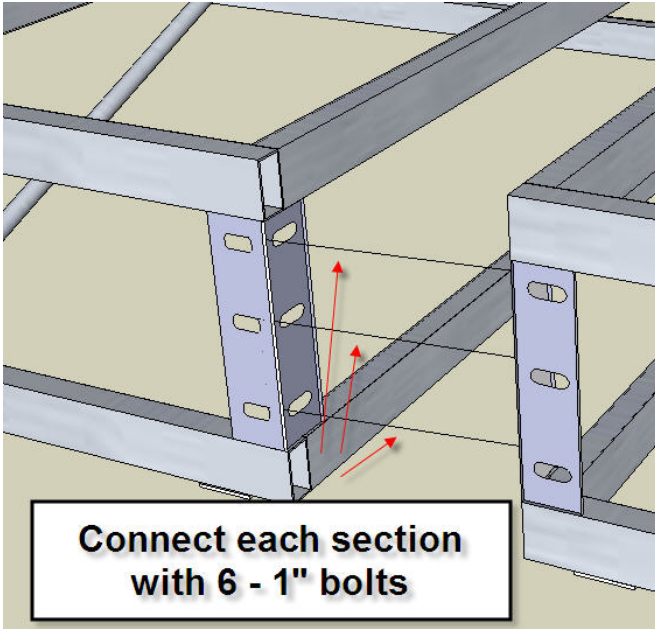

Connect frames with hardware as shown. Carriage head fits into slot so it will not spin when tightening.

Anchoring post installation

Begin by attaching the pockets to the side of the dock. In general every 20-30 feet apart is a good guide for spacing the pockets, but for a small system you can place the pockets closer together, especially up front or in areas where they are out of the way. For longer systems try to keep them evenly spread throughout the system. Please consult Pier Genius should you have any questions.



Spud pocket with hardware

Once the pocket is attached, prepare to cut your anchoring pipe (if required) to the correct length. That can be determined by the following formula:

$$\text{Length of anchoring pipe} = \text{Bottom type min value (see below)} + \text{Water depth at spud pocket location} + \text{max water fluctuation from current install water level} + 3'$$

The new pipe (if supplied by Pier Genius) comes standard in 21' lengths. Cutting the pipe makes it easier to handle in shallow water locations. If your calculation results in a number greater than 21' please contact Pier Genius immediately. Once the pipe is ready, simply drop it in the pocket maintaining it as level and straight as possible while lowering the pipe. Next, pound the pipe into the lake bed until the pipe stops moving freely.

The following guide is useful for determining how deep to anchor pipe into various lake beds, although actual depths can vary due to different factors, such as water currents and local codes. If you are unsure, please contact Pier Genius:

Sand bottom = 15" Min

Mud/Sand mix = 24" Min

Muck/silt = 48" Min

Cleat Installation

There are two methods to fasten the cleats to the dock. The first method is to attach the cleats into the aluminum PG Deck track. This method allows the cleats to be positioned anywhere along the panel, however, the panels must be **bolted** to the frame NOT screwed into the frame.

The 2nd method is to drill through the aluminum track, through the frame, and permanently mount the cleat in that location.



Method #1 Cleat and hardware for the aluminum track install

When using method #1, place the cleat on top of the rail and in the desired location, then put the bolt through the lock washer, flat washer, and lastly, into the cleat. Place the rectangle nut into the channel and rotate it 90 degrees. Screw the bolt/cleat assembly and tighten it until the lock washer is tight but not deforming.



Method #2 Cleat and hardware for the permanent attachment method when panels are screwed in place vs bolted

When using method #2, place the cleat on top of the rail and in the desired location, then mark and drill a ½” hole through the aluminum and the steel tube. Insert the bolt into the cleat until the head is flush with the top of the cleat and insert the bolts into the drilled holes. Place the flat washer and nut on the bottom of the tube and tighten it until the tube just begins to deform slightly and stop.

Bumper Installation

There are two types of frame bumpers offered by Pier Genius: straight bumpers and corner bumpers. Both attach via friction fit and can mount anywhere along the side of the dock. To attach the bumpers to the frame, use a back plate and run a bolt through the bumper to hold it onto the frame. **NO DRILLING INTO THE METAL FRAME IS REQUIRED.**



Mounting bracket and hardware that comes with either bumper assembly

The mounting bracket will work for either the corner or the frame bumper. When using the corner bumpers, you will ONLY use the middle slot in the bracket. When using the straight bumpers, you will only use the top and bottom slots. The bumpers are easiest to install with the decking off; however, removing the decking is not required. Simply use the supplied bolts and insert them into the bumper, then hold the bumper against the frame. Place the mounting plates behind the bumper and secure them with the washer and the nut sets.

NOTE: If you are hooking up to the side of the dock and the top tube is 2" wide and the bottom tube is 1" wide, the mounting bracket will sit at an angle and that is OK.



Mounting bracket and bumper installed (corner mount shown)

Closure Strip

If you optioned on the closure strips to cover the PG Deck track, simply cut it to the specific length you need and snap into place. A rubber mallet can make this a little easier.

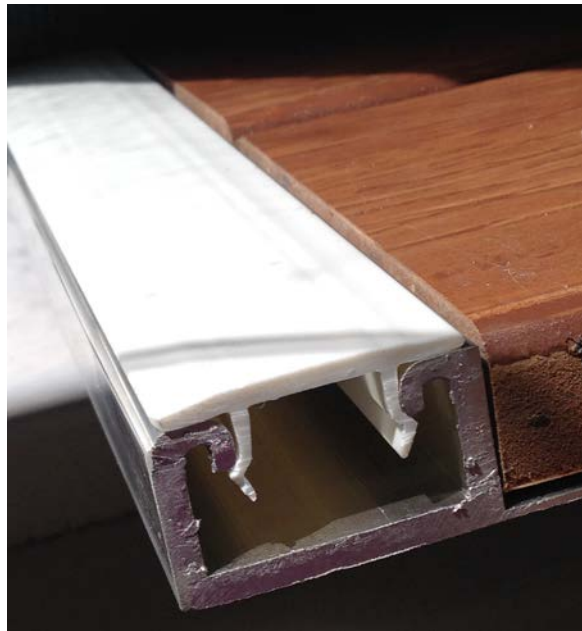

And now we have closure! ;-)

That's all it takes! You can now bolt together your complete dock, float it into place and secure it with a hinge and/or pipes pounded into the water bed. Enjoy your new Anti-Sway™ dock, and congratulations on purchasing the **most stable** floating dock on the market!

Please send us 'beauty shot' pictures for an opportunity to star in our catalog, as well as receive other incentives! Also please **LIKE** us on Facebook to see our latest happenings, witty entertainment, or just to brag about your awesome dock with other dock aficionados!



Sincerely,

Your Friends at
Pier Genius

